

Polarization Measurements of Signals and Components

Product Note 8509-1

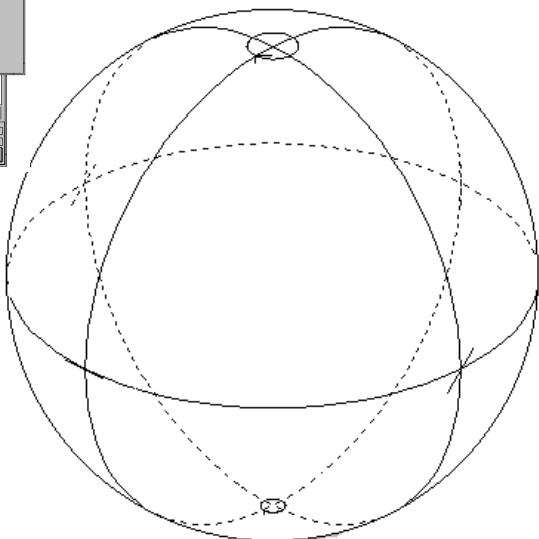
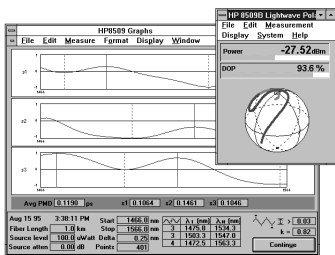
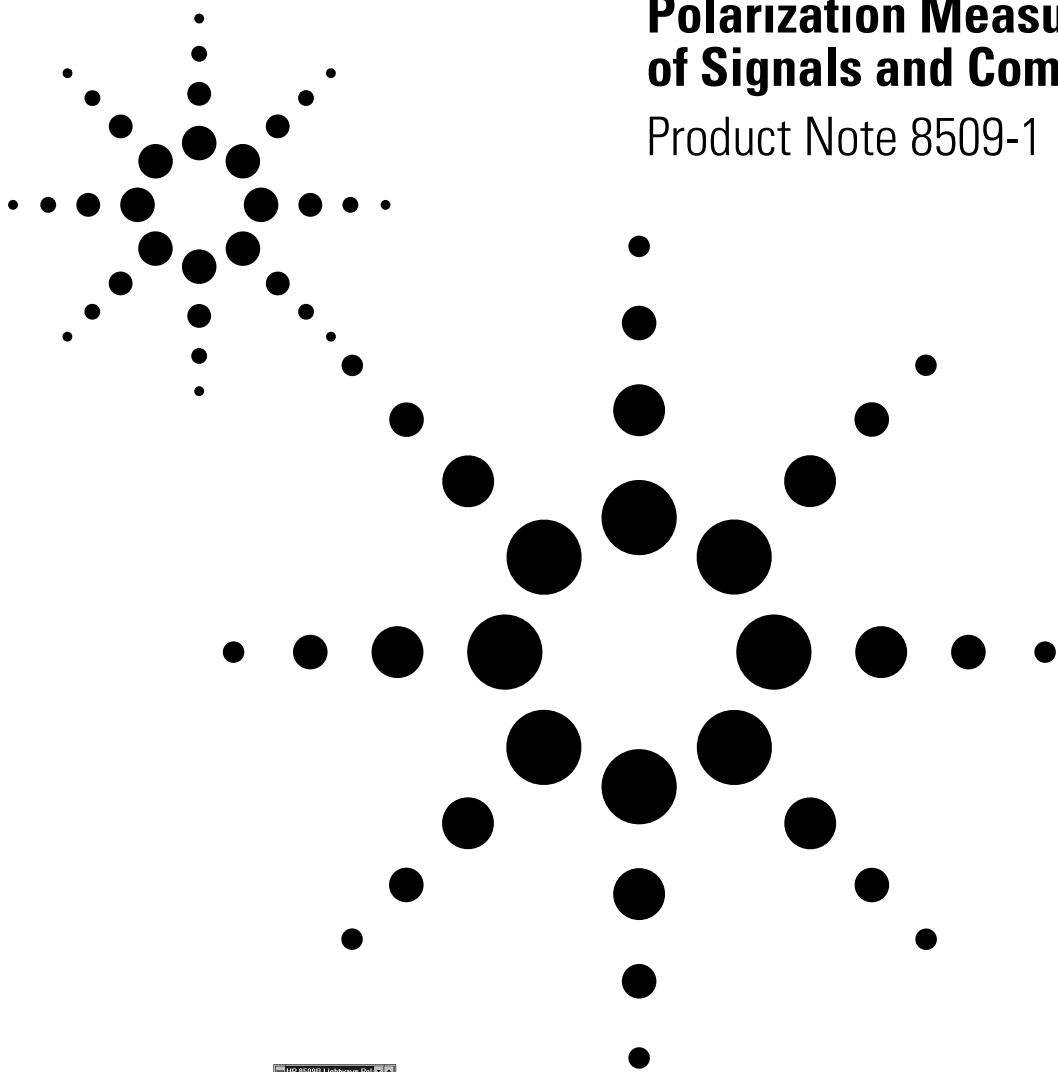

**Agilent 8509B/C Lightwave
Polarization Analyzers**

Contents

	page
Introduction	2
Analyze the Polarization of Optical Signals	
State of Polarization.....	3
Polarization Reference Frame.....	10
Measure the Polarization	
Transfer Function of Components	
Polarization Transfer Function.....	7
Polarization-Dependent Loss.....	12
Polarization Mode Dispersion.....	13
Polarization-Maintaining Fiber Launch.....	16
Appendix	18
Technical References	23

Introduction

As the lightwave component and system technology advances, mechanisms that degrade performance are continually discovered and then eventually overcome only to raise the relative significance of other performance barriers. Past advances have minimized the optical transmission problems of multimode dispersion and chromatic dispersion which expanded the field of new lightwave applications and pushed optical technology up against the challenges and opportunities of optical polarization effects.

Polarization effects change an optical signal by altering the relative magnitude and phase of the signal's E-field components. These changes are due to the interaction between the polarization of the optical signal and the polarization transmission properties of optical components.

In some cases, polarization effects are used to improve device and system performance. Such is the case with optical isolators that use polarization effects to prevent reflected optical signals from interfering with forward transmissions.

In other situations, polarization effects are a liability and must be minimized to prevent performance reductions. Long-haul telecommunication systems, for example, have shorter transmission distances and poorer bit error ratios when polarization-dependent loss and polarization-mode dispersion are present.

In the lab and on the production line, scientists, engineers and technicians use the speed, accuracy and convenience of the Agilent 8509 lightwave polarization analyzer to measure and predict the polarization of optical signals and the

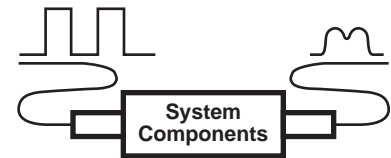

Figure 1. Polarization-mode dispersion and polarization-dependent loss can degrade system performance by introducing power loss and signal distortion.

polarization transmission properties of optical components and systems. Data is displayed in simultaneous graphic and numeric formats (i.e., average power, degree of polarization, Poincare sphere, polarization ellipse, Jones matrix and Stokes parameter formats).

Each measurement section of this product note briefly introduces related polarization phenomena, and presents measurement setups, procedures and typical 8509 test results.

For further information about the Agilent 8509B and 8509C block diagrams and measurement capabilities refer to Appendix A. For system configuration, operation and performance specifications, refer to the product overview (literature number 5988-1044EN).

Measurement examples

The following measurements require clean connectors for the best results.

State of polarization

Introduction

The state of polarization (SOP) of a lightwave signal describes the E-field magnitude and phase relationships inside the signal. A signal's polarization state affects how that signal mixes with other lightwave signals and how it will be affected by the polarization transmission properties of optical components.

For example, degree of polarization (DOP, defined later) is a part of SOP which may affect the amplitude modulation characteristics of an optical modulator. Figure 2 shows the optical output relative to a swept modulation frequency (130 MHz to 20 GHz). The solid trace represents when the source and isolator deliver a 100% DOP signal to the modulator. The dotted trace shows the response when a 10% DOP signal is provided. A lower DOP input signal delivers less power to the modulator's preferred polarization axis causing a 3 dB drop in the conversion efficiency of the modulator.

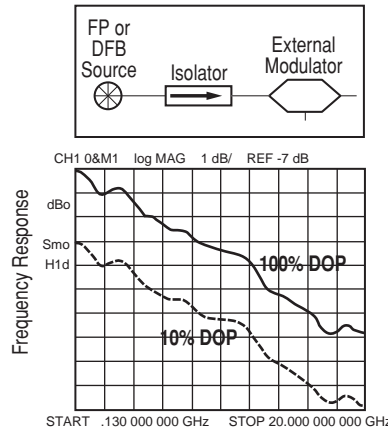

Figure 2. Degree of polarization of an optical input signal affects optical modulator performance.

The following is a more detailed discussion of signal polarization in terms of E-field relationships, degree of polarization, Jones vectors, Stokes vectors, elliptical displays and Poincare sphere displays.

E-field polarization

The electric fields of an optical lightwave can be resolved into two arbitrary, orthogonal vector components, $E_x(t)$ and $E_y(t)$. The state of polarization of a lightwave signal is determined by the relative magnitude and phase of these E-field vector components that are simultaneously present in the lightwave.

$$E_x(t) = A_x \cos(\omega t + \phi_x) i$$

$$E_y(t) = A_y \cos(\omega t + \phi_y) j$$

$$E_r(t) = E_x(t) + E_y(t) = \text{Re}(A_x e^{j(\omega t)} i + A_y e^{j(\omega t + \Delta \phi)} j)$$

where A_n is the magnitude of the E_n vector, ω is the optical frequency in radians per second and ϕ_n is the absolute phase of E_n .

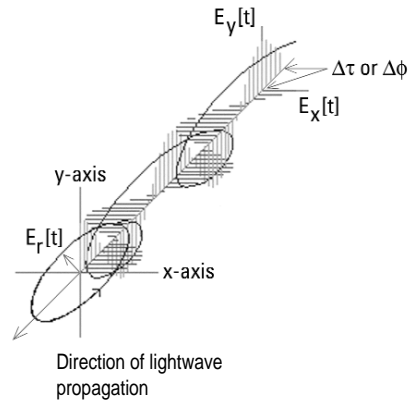

Figure 3. Polarization changes with $E_x(t)$ and $E_y(t)$

Degree of polarization

In most lightwave signals part of the total energy is polarized and part of it is unpolarized. Degree of polarization (DOP) is a measure of what percentage of the total average lightwave signal power is polarized.

$$DOP\% = (\text{Polarized Power} / \text{Total Power}) \times 100\%$$

Jones vector

If the lightwave is completely polarized (DOP= 100%) then a 2 X 1 complex Jones vector describes the polarization in terms of the E-field components. This is the same E-field representation discussed under "E-Field Polarization".

$$\text{Jones Vector } J = \begin{bmatrix} A_x e^{j(\omega t)} \\ A_y e^{j(\omega t + \Delta \phi)} \end{bmatrix}$$

The 8509 does not display the Jones vector format. However, Jones vector data can be calculated from the 8509 Stokes parameters discussed under "Stokes Parameters".

Elliptical displays of polarization

Any state of polarization can be created by adjusting the magnitude and phase relationships of the $E_x(t)$ and $E_y(t)$ components of a lightwave signal. All polarization states can be shown as unique elliptical displays. Several classical examples are shown below. Notice the E-field magnitude and phase relationships for each case.

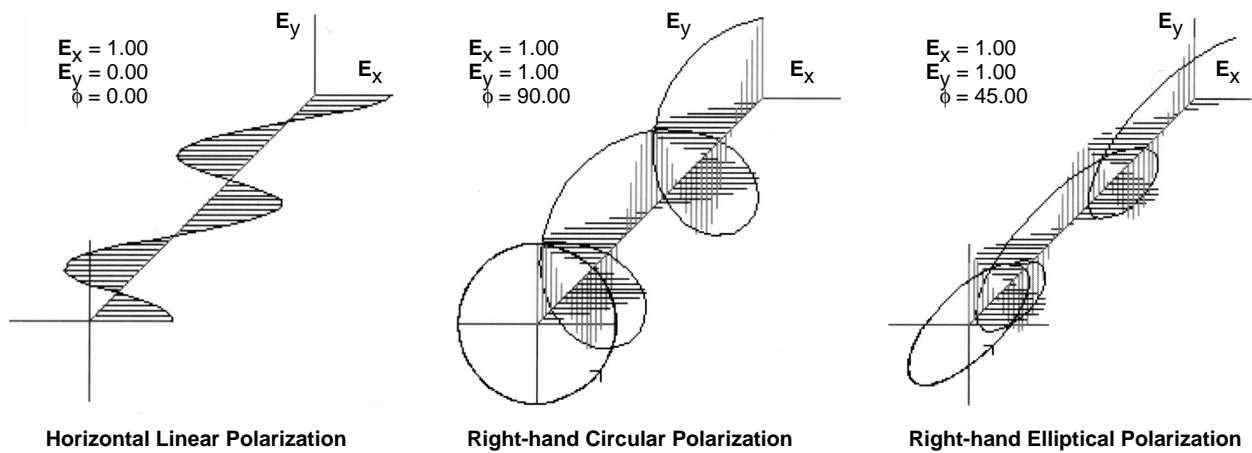
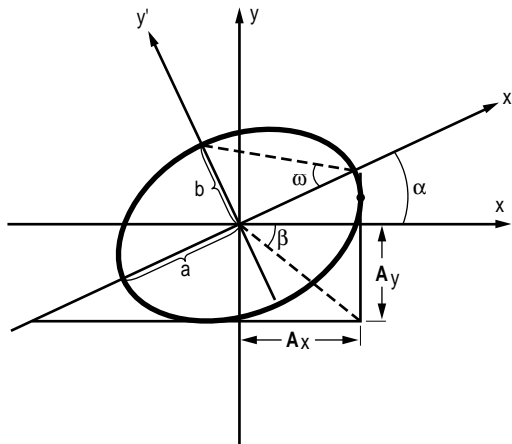

Figure 4. Linear, circular and elliptical states of polarization occur depending upon the magnitude and phase of the signal's $E_x(t)$ and $E_y(t)$.

Each elliptical display can also be quantified by its azimuth (α) and elliptical angle (ω) as shown below.



where a = length of semi-major axis, b = length of the semi-minor axis, ω = the elliptical angle, α = azimuth or tilt of the X', Y' axes, A_n = magnitude of E_x and E_y -fields and $\beta = \tan^{-1}(A_y/A_x)$

Figure 5. Each elliptical display is unique according to its azimuth and elliptical angle.

Poincare sphere

The Poincare sphere is an excellent display format for monitoring signal-polarization changes, since all states of polarization are seen at the same time. This is accomplished by assigning each state of polarization its own specific point on the Poincare sphere. Points on the equator represent states of linear polarization, the poles represent right-hand and left-hand circular polarization, and other points on the sphere represent elliptical polarization (see Figure 6).

Each point on the 8509 Poincare sphere has a unique set of coordinates defined by the sphere's three-dimensional axes s_1 , s_2 and s_3 shown in Figure 6. These coordinates are called normalized Stokes parameters.

Stokes parameters

A Stokes vector is a 4 X 1 real matrix of Stokes parameters (S_0 , S_1 , S_2 and S_3) that completely describes the state of polarization of a lightwave. Each element of the matrix is based upon measured power levels (I_n). S_0 is the average power of the entire light beam (I). S_1 is the difference in power between the horizontal and vertical linear polarization components of the beam ($I_0 - I_{90}$). S_2 indicates the power difference between +45-degree and -45-degree linear polarization ($I_{45} - I_{-45}$). S_3 is the power difference between the right-hand (rcp) and left-hand circular (lcp) polarization ($I_{rcp} - I_{lcp}$). The Stokes vector has a magnitude equal to $(S_1^2 + S_2^2 + S_3^2)^{1/2}$ and originates from the center of the Poincare sphere.

The 8509 display combines average power, S_0 , with normalized Stokes parameters ($s_1 = S_1/S_0$, $s_2 = S_2/S_0$, $s_3 = S_3/S_0$) and the Poincare sphere. For example, a horizontal-linear, polarized light beam has the (s_1, s_2, s_3) coordinates of (1,0,0). This is a point on the equator of the Poincare sphere (see Figure 6). (-1,0,0) is a point on the equator where the polarization is vertical linear.

Stokes parameters are related to DOP by¹:

$$DOP = (S_1^2 + S_2^2 + S_3^2)^{1/2} / S_0 = (s_1^2 + s_2^2 + s_3^2)^{1/2}$$

Notice that the magnitude of a normalized Stokes vector ($= (s_1^2 + s_2^2 + s_3^2)^{1/2}$) is equal to the DOP for the same optical signal. This means that signals of different DOP are at different distances from the center of the Poincare sphere. This makes the signals difficult to compare. The 8509 Poincare sphere display

simplifies this comparison by graphically projecting the normalized Stokes vector termination point onto the surface of a unity radius sphere, even when the magnitude of the normalized Stokes vector is not equal to one. With the 8509 Poincare sphere display format, the polarized components of a 100% DOP signal and a 10% DOP signal both appear on the surface of the sphere and are easier to analyze.

For completely polarized light-wave signals (DOP=100%), Stokes vectors can be converted to Jones vectors using the E-field relationships and conditions presented in Appendix B, Table 2.0. This is helpful since the 8509 does not directly provide data in Jones vector format.

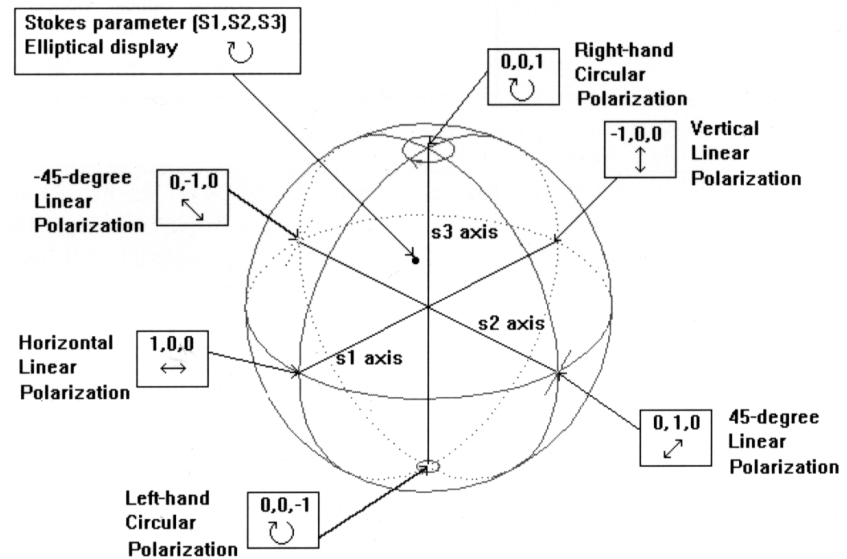

Figure 6. Polarization states can be described using an elliptical display, a point on the Poincare sphere or a set of Stokes parameters.

Summary

The state of polarization of an optical signal is expressed in terms of average power, DOP, elliptical polarization displays, Stokes parameters and the Poincare sphere. The Agilent 8509 offers these in one display for an easier, more complete understanding.

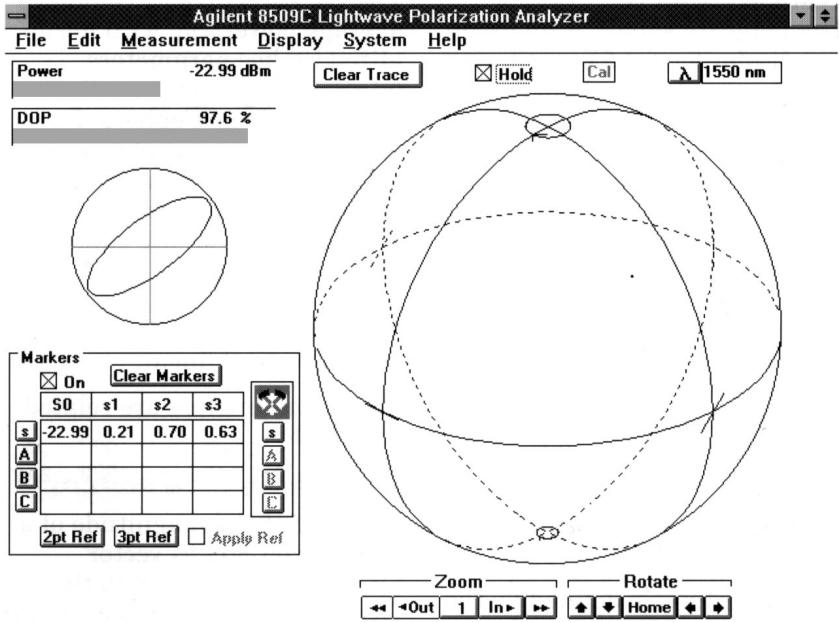

Figure 7. The Agilent 8509 displays the state of polarization of optical signals in a variety of important formats.

Measurement setup

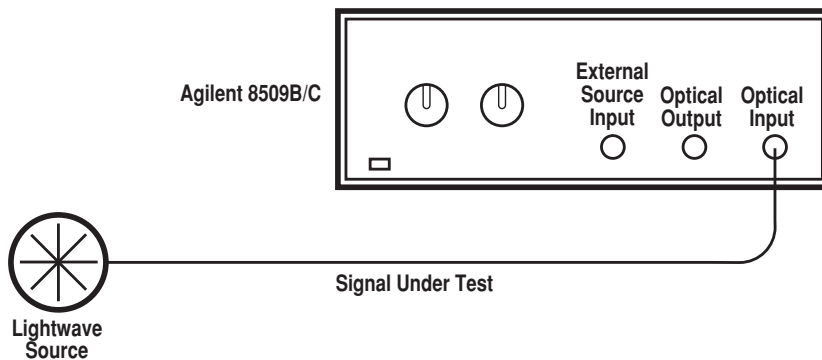

Figure 8. Setup for state-of-polarization measurements

Test procedure

Once the input cable is connected to the 8509 OPTICAL INPUT, state of polarization data is displayed automatically.

Polarization transfer function

Introduction

The lightwave polarization transfer function of a component changes the state of polarization and magnitude of an optical signal and is described by a Jones matrix. The 8509 measures the Jones matrix of bulk-optic and fiber-optic components. It also uses the Jones matrix internally to calculate calibrated polarization reference frames (PRF), polarization-dependent loss (PDL), and polarization-mode dispersion (PMD). See the “Contents” section to find further information about these measurements.

A Jones matrix is a 2 X 2 complex matrix which describes the polarization transfer function of a component given a completely polarized lightwave (DOP=100%) input. For example, if a polarized lightwave is transmitted through a component, the Jones matrix for that component describes how much the magnitude and phase of the E_x and E_y fields of the output lightwave will have changed relative to the original input lightwave. It is assumed that the polarization transfer function of the component is not changing with time and only linear interactions between the lightwave and the component occur (i.e., frequency doubling or mixing are not occurring). Figure 9 is an example of how the Jones matrix is used to predict the polarization of the output signal given that the polarization of the input signal and Jones matrix of the component are known.

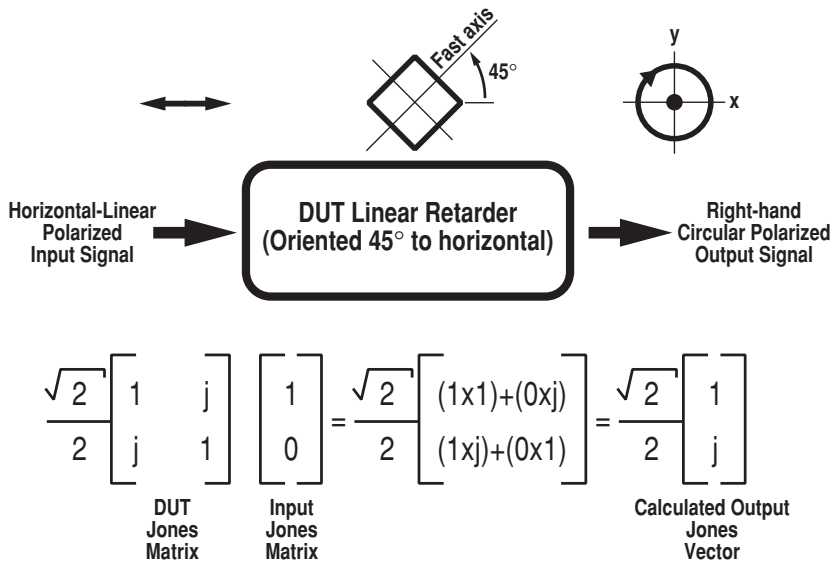

Figure 9. Jones matrix calculations predict that a quarter-wave retarder, oriented 45 degrees to horizontal, will create a right-hand circular, polarized output when excited by a horizontal-linear, polarized lightwave².

The 8509 LPA calculates both a relative and a calibrated-magnitude Jones matrix using techniques originally developed by R.C. Jones (See Appendix C for further details). A relative Jones matrix describes all polarization transforming properties of a device except for the absolute attenuation or gain. A calibrated-magnitude Jones matrix also describes the polarization transforming properties of a device; plus, it contains the device’s absolute attenuation or gain response relative to a fiber thru calibration. In either case, absolute E-field phase change information is not available.

Jones matrix measurements and calculations are used effectively when the birefringence and dichroisms of the transmission or reflection medium of the DUT and the test system are not changing.

Bulk-optic components

Lightwave polarization is preserved in air, which makes it an excellent medium in which to measure the Jones matrix of a bulk-optic component and to measure the polarization output for specific cases of polarization input.

For example, the measurement trace on the Poincare sphere in Figure 10 shows the traditional figure-eight shape of the output SOP of an bulk-optic, quarter-wave plate retarder while it is being rotated 360 degrees. The input to the quarter-wave plate is a linearly polarized beam as indicated by the figure-eight response crossing the equator of the Poincare sphere in Figure 10. The average power, DOP, elliptical display and Stokes parameters show data for only the present input lightwave signal.

Notice the wave plate is not an exact quarter-wave retarder at the 1550 nm test wavelength as evidenced by the measurement trace not reaching the poles of the Poincare sphere. At a 1550 nm wavelength, this wave plate could not produce the necessary 90-degree delay between the E_x and E_y axis to create a circular state of polarization (see Figure 4 to review the E-field relationships of circular polarization). This could also be calculated without actually doing a measurement by simply using the Jones matrix of the linear retarder and a mathematical procedure similar to the one shown in Figure 9.

Fiber optic components

Lightwave polarization is generally stable in a single-mode fiber cable as long as the cable is not moved. Moving the cable changes the birefringence of the cable, which alters its polarization transfer function.

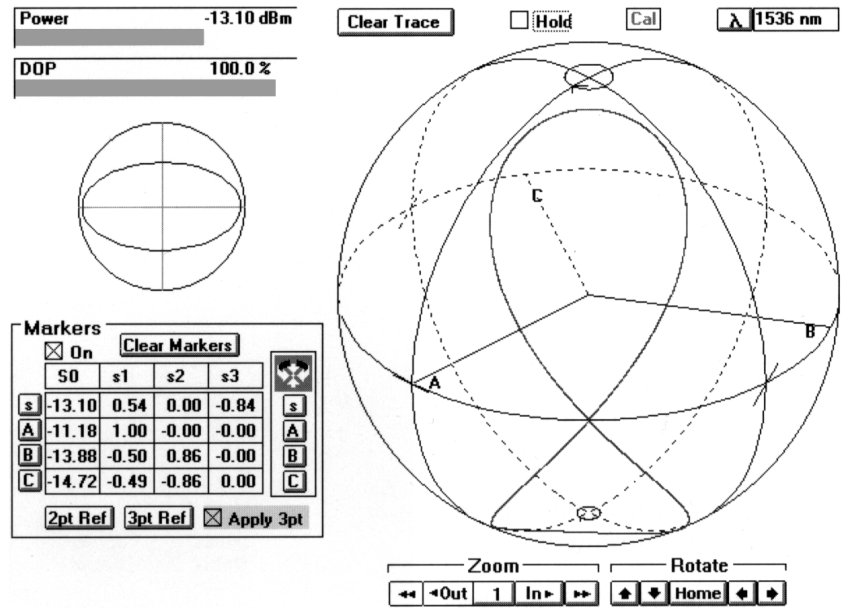

Figure 10. The 8509 displays a past-and-present SOP measurement trace on the Poincare sphere while a rotating, bulk-optic wave plate is measured.

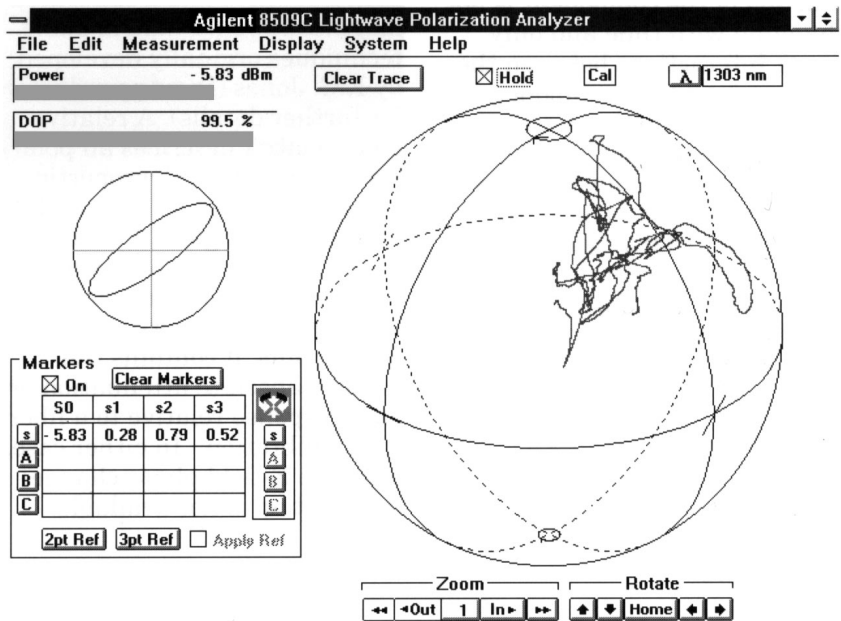

Figure 11. Twisting a single-mode fiber changes its polarization transfer function, which appears as random polarization changes on the 8509C Poincare sphere.

Components, which are connected to the 8509 using single-mode fiber (SMF), can also be tested, however, aspects of their effective Jones matrix will be altered when the connecting cables are moved. Some properties of their Jones matrix, however, are not altered when the connecting cables are moved. The Agilent 8509 uses these invariant properties to calculate the polarization-dependent loss (PDL) and polarization mode dispersion (PMD) properties of fiber optic components using Jones matrix analysis.

Measurement setup

In this example, the relative Jones matrix of a bulk-optic device is tested in an open-beam setup. A similar test could also be done on a fiberized device using the internal polarizers of the 8509C.

Test procedure

The 8509C's internal sources are used for this example. Other external sources of different wavelengths can be used with the 8509B or 8509C when the external source preparation procedure, under the "Polarization Mode Dispersion" section, is followed.

Make the following selections on the 8509 display to perform a relative Jones matrix measurement. All optical fibers should be taped down to prevent movement during this procedure.

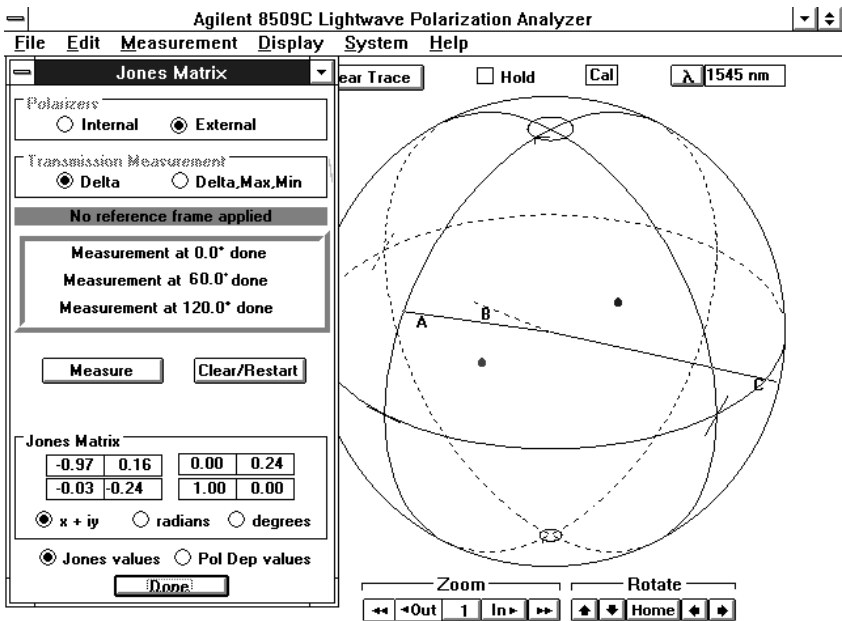

Figure 12. Typical 8509C Jones matrix measurement data can be shown in three formats: $x+jy$ and magnitude/phase in radians and degrees.

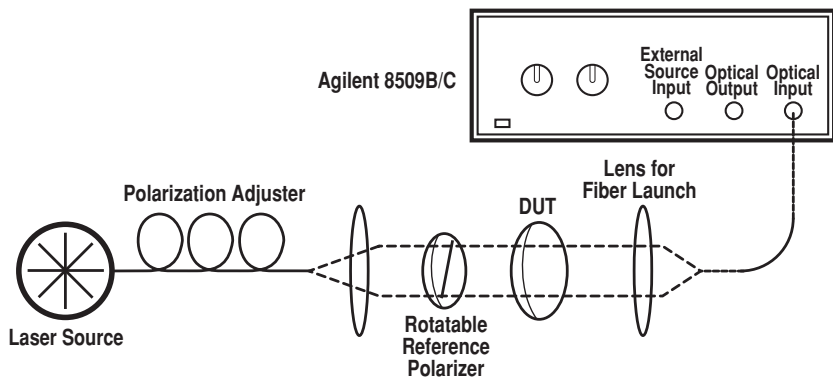

Figure 13. Setup for measuring the Jones matrix of an unknown bulk-optic device (DUT)

Typical measurement procedure

1. **System**
2. **Optical Source**
3. Select the appropriate internal laser wavelength.
4. **Done**
5. **Measurement**
6. **Jones Matrix...**
7. **External**
8. **Delta**
9. Connect the device.
10. Set external polarizer angle to 0 degrees and select **Meas at 0.0.**
11. Set external polarizer angle to 60 degrees and select **Meas at 60.0.**
12. Set external polarizer angle to 120 degrees and select **Meas at 120.0.**
13. Data appears in the Jones Matrix data window.
14. Select **Done** if no more devices are to be tested; otherwise, select **Clear/Restart** and return to step number 10.

Polarization reference frame

Introduction

A polarization reference frame enables the polarization of light-wave signals to be tested at a physical location relative to known reference standards, usually reference polarizers. This is valuable for optical sensor and bulk-optic sub-system applications where a specified polarization reference frame is needed for results to be accurately interpreted, reproduced and documented.

Traditionally this has required the optical receiver to be directly in the beam path. This is awkward and is not suitable for many applications. An interface fiber can be used to carry the signal from the open-beam path to a conveniently placed receiver as shown in Figure 15; however, the fiber will alter the signal polarization as previously shown in Figure 11. Fiber cable can still be used if a calibration procedure removes the polarization transforming effects of the fiber.

This type of calibration is done quickly and easily using the Jones matrix capabilities of the Agilent 8509B or 8509C. The polarization altering effects of the fiber between the polarization reference frame location and the test system, shown in Figure 15, are measured and removed to provide accurate and repeatable data of the signal's polarization at the reference frame location.

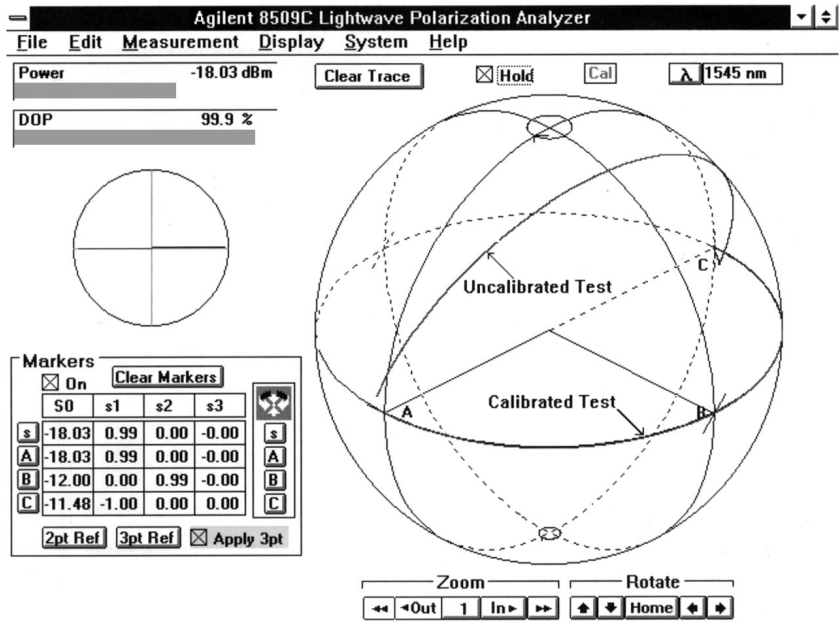

Figure 14. A calibrated 8509 system removes the fiber effects of the 8509 test system to accurately measure the output from a linear polarizer as it is rotated from 0 to 90 degrees.

The 8509 calibration process starts by measuring the Jones matrix of the optical path between the reference frame location and the Agilent 8509's internal receiver. The internal polarizers of the 8509C or an external, rotatable, linear polarizer is used as the reference-polarizer standard for a Jones matrix measurement. This Jones matrix describes the polarization altering affects of the test system. When a polarization reference frame is activated, the Jones vector of the incoming test signal is measured and processed through the inverse Jones matrix of the path between the reference polarizer and the 8509 receiver. This removes unwanted transformations and leaves behind the polarization of the lightwave signal as it appears at the PRF point.

When a PRF is established prior to a PDL, PMD or Jones matrix measurement the test system's polarization transforming effects are removed and the measurement data corresponds to known input and output SOP. Refer to the respective sections of this document for further PDL, PMD or Jones matrix measurement information.

Measurement setup

This is a setup for an external source and an 8509B or 8509C. The internal sources of the 8509C could also be used by connecting the DUT between the 8509C's OPTICAL OUTPUT and OPTICAL INPUT.

circular polarization by completing the PRF procedure, removing the rotatable polarizer and clearing the trace on the Poincare sphere (select **Clear Trace**). Note the absolute value of s_3 for the S marker in the Marker window. If it is not greater than 0.9, adjust the polarization adjuster of Figure 15 until the active data point

Once a reference frame is established, the reference polarizer and any part before the reference polarizer (namely, the source assembly) can be adjusted, moved or even replaced without affecting the PRF. However, no part of the signal path after the reference polarizer can be moved without invalidating the PRF.

Figure 15. Setup for creating a polarization reference frame in an open-beam environment.

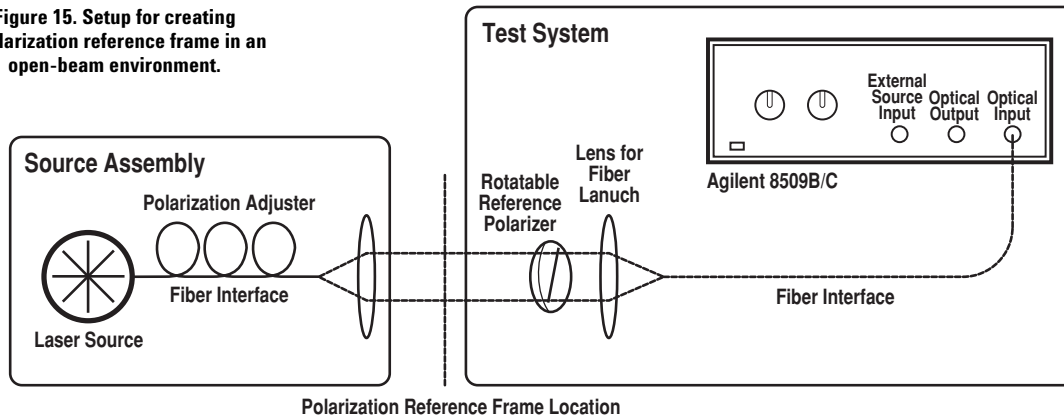

Polarization reference frame procedure

Upon completing this procedure the 8509 display will show the SOP at the “polarization reference frame location” in Figure 15. The signal from any lightwave source assembly that is composed of a laser and a polarization adjuster, such as the Agilent 11896A, can be used.

Be sure all fibers are taped down before beginning this procedure. Movement of any SMF cables during the calibration will invalidate the process and make it necessary to start again. Make the following selections on the 8509 display to perform a calibration using external polarizers.

This procedure works best when the source supplies a circular SOP. With a circular SOP input signal there is no chance for a low-power (-45 dBm) reference point caused by the rotatable polarizer being placed orthogonal to a linear SOP input signal. Check for

Typical measurement procedure

1. **System**
2. **Optical Source**
3. Select the appropriate internal or external laser source and wavelength.
4. **Done**
5. **System**
6. **Polarizers**
7. Select **External** and note the angles for A, B and C. They are typically 0.0, 60.0 and 120.0 degrees.
8. **No Polarizers**
9. **Done**
10. Set external polarizer to angle A and select **A** marker.
11. Set external polarizer to angle B and select **B** marker.
12. Set external polarizer to angle C and select **C** marker.
13. Select **2pt Ref** or **3pt Ref**. In the absence of PDL in the test system setup, the quicker 2pt Ref can be used. If there is some doubt about the test systems PDL refer to page 26 and perform a PDL test on the test system itself (using a SMF cable as the DUT). The 3pt Ref should be used whenever PDL is present in the test system setup.
14. Check the quality of the reference frame by selecting **System** and **Reference Frame Info**. Select **OK** to proceed.
15. If the reference frame is acceptable then select **Apply** and an X will appear in the box next to the Apply label; otherwise, return to step 6 and try again.

approaches a pole on the Poincare sphere and s_3 is greater than 0.9; then repeat the PRF procedure.

Polarization-dependent loss

Introduction

Polarization-dependent loss (PDL) describes the absolute value or the relative difference between an optical component's maximum and minimum transmission loss or gain, given all possible input states of polarization. This is called extinction ratio in the case of polarizers. PDL values range from less than 0.05 dB for optical connectors and cables to greater than 30 dB for optical polarizers.

PDL is generally an illusive power loss mechanism. This is not because the PDL properties of components are changing but because the polarization state of a transmitted signal is varying randomly with time. Random combinations of an individual component's PDL creates intermittent changes in the total loss of the system. Chances of system failure due to PDL are minimized by testing the PDL of each component and including this value in worst-case power calculations and in bit error-rate estimations.

The Agilent 8509C uses a Jones-matrix technique (see Appendix D for further information) to automate and simplify the PDL measurement, accurately completing it in approximately two seconds.

Measurement setup

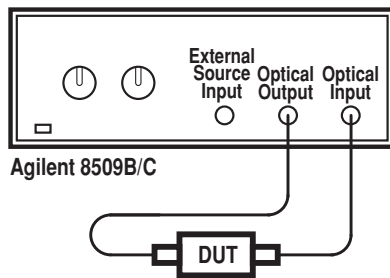

Figure 17. The 8509C system setup for polarization-dependent loss testing.

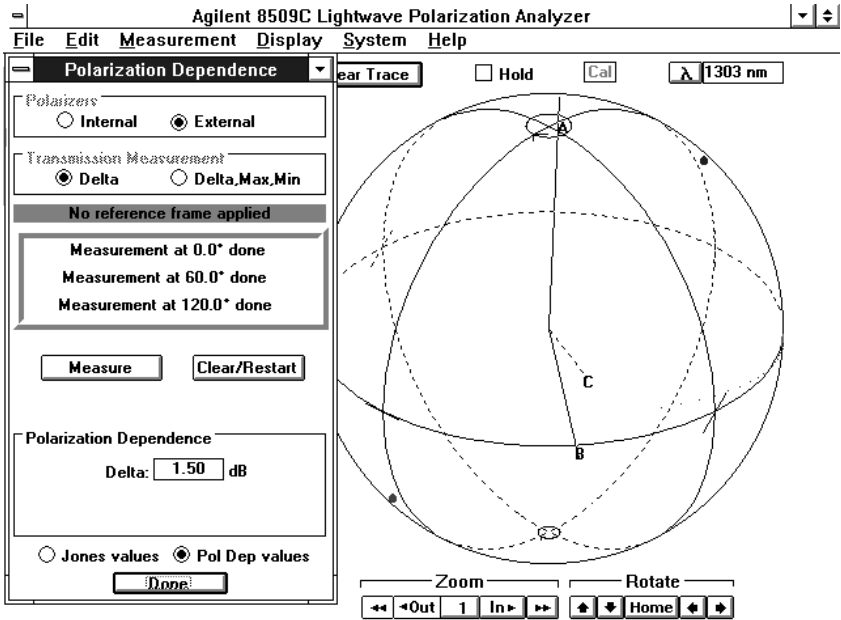

Figure 16. Typical data display for the 8509 PDL test.

Test procedure

A relative PDL measurement can be performed by making the following selections on the 8509 display.

Typical measurement procedure

1. **System**
2. **Optical Source**
3. Select the appropriate laser source and wavelength.
4. **Done**
5. **Measurement**
6. **Polarization Dependence...**
7. **Internal**
8. **Delta**
9. Connect the device
10. Select **Measure** and the test data will appear in the Polarization Dependence data window.
11. Select **Clear/Restart** an return to step 7 to test more devices; otherwise, select **Done**.

Accuracy is affected by the PDL of the optical connectors, the physical stability of the fibers during the test procedure, the DOP of the source, and the test signal power level. Accuracy is also degraded when the DUT

depolarizes the test signal. This can occur when the differential group delay (between E_x and E_y), caused by the DUT, is greater than the coherence time ($= 1/(\text{line width of the source in Hz})$) of the test signal.

Polarization mode dispersion

Introduction

Polarization mode dispersion (PMD) is an intramodal distortion mechanism (like chromatic dispersion) that causes optical devices, such as single-mode fiber, optical switches and optical isolators, to distort transmitted signals. Its relative severity has increased as techniques for dealing with chromatic dispersion have improved, transmission distances have increased, and gigabit rates and frequencies have been achieved. Negative effects of PMD appear as random signal fading, increased composite second order distortion and increased error rates.

PMD is due to differential group delay caused by birefringent and geometrical irregularities in the transmission path of the component. For example, a single-mode fiber is described as a homogeneous medium supporting only one mode. In practice it supports two polarization propagation modes, E_x and E_y . The relative propagation velocity of energy in each mode will vary randomly during transmission causing changes in the state of polarization of the transmitted lightwave signal. Changes in polarization affects polarization sensitive mechanisms, like PDL, causing other random changes in the optical signal.

Both direct and coherent detection techniques can be affected by PMD distortion which appears as pulse broadening. When a lightwave source of finite line width transmits a lightwave pulse into a SMF cable, the pulse energy is resolved into the principle states of polarization for the fiber and launched on to the fast and slow axes of the fiber, respectively E_x and E_y . The two groups of pulse energy propagate at different velocities and arrive at different times causing pulse broadening (see Figure 18). If the delay is

greater than the coherent time of the source ($= 1 / (\text{line width of the source in Hz})$), then signal depolarization can also occur, affecting coherent detection techniques even more.

The 8509C performs this test automatically and accurately using the Jones-matrix eigenanalysis technique (see Appendix E

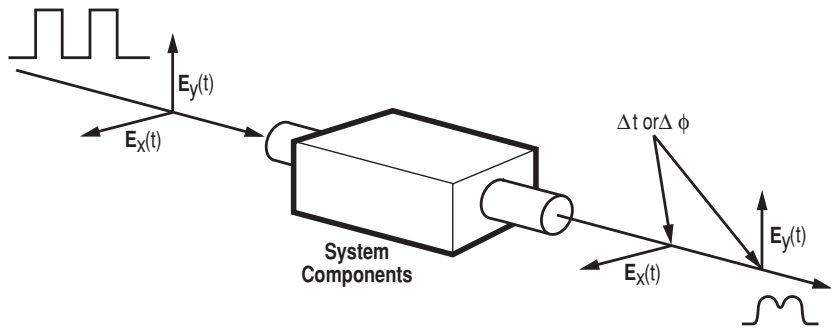

Figure 18. Pulse broadening can be caused by polarization-mode dispersion.

By knowing the PMD of all components in a system, designers and application engineers can reduce PMD and specify maximum PMD tolerances for certain applications.

PMD is generally specified in picoseconds and is displayed as shown below in the 8509C PMD test window.

for further information). This technique offers the advantages of accurate, repeatable measurements that are user independent and unaffected by any relationships between the input polarization and the DUT's principle states of polarization.

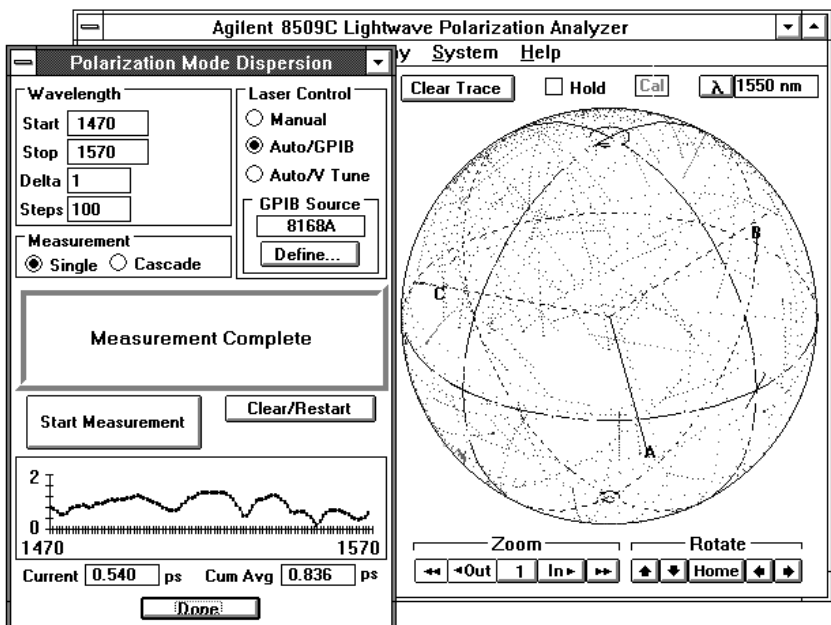

Figure 19. Agilent 8509C systems measure polarization mode dispersion.

Measurement setup

A tunable laser source is required for this application. The Agilent 8164 or 8168 tunable, external-cavity laser sources are recommended. Keep in mind that the wavelength accuracy, stability and resolution of the tunable light-wave source will affect PMD test accuracy.

A GPIB cable (not shown) will also need to be connected between the 816X and the Agilent 8509C system computer for automatic PMD measurements.

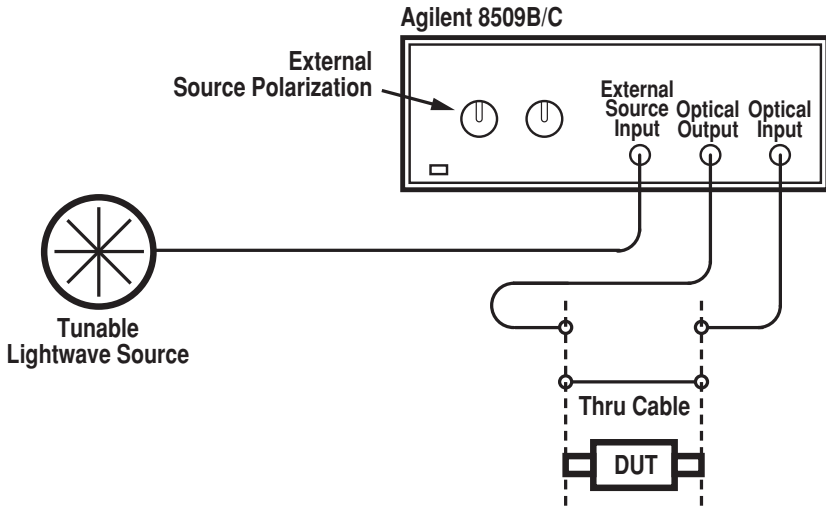

Figure 20. Configuration for 8509C measurements of polarization mode dispersion.

Test procedure

An automatic or manual PMD test can be done by making the following selections on the 8509C display. Be sure the fiber cable leading from the external source to the 8509C EXTERNAL SOURCE INPUT is taped down since cable movement during and after the procedure may jeopardize PMD measurement accuracy.

External source preparation procedure

1. Connect a fiber cable from the Agilent 8509C OPTICAL OUTPUT to the OPTICAL INPUT. Set the tunable external source for maximum output not exceeding 10 dBm.
2. **System**
3. **Optical Source**
4. Select the **External Source** and enter the appropriate wavelength.
5. **Done**
6. **System**
7. **Polarizers**
8. **Internal**
9. **No Polarizers**
10. **Done**
11. **3pt Ref** (wait five seconds)
12. **Apply 3pt** (an X should appear in the adjacent box)
13. Adjust the External Source Polarization knobs on the front panel of the Agilent 8509C (or the external source's polarization adjuster depending on the setup) until the active point on the Poincare sphere approaches a pole and the absolute value of s_3 (for the S marker) is greater than 0.90. This ensures a circular polarization input to the 8509C's internal polarizers
14. **Un-apply 3pt**

Typical measurement procedure

14. **Measurement**
15. **Polarization Mode Dispersion...**
16. Select **Manual** if the source is manually tuned. If the Agilent 8164 or 8168 source is used, select **Auto/GPIB** and **Define**. Enter the appropriate GPIB address. Set the settling time according to the wavelength step size (1 nm/ 10 nm /100 nm step size corresponds to 150 ms/ 300 ms/ 2 s settling time).
17. Set wavelength conditions: **Start, Stop, Delta** and **Steps**.
18. **Single**
19. Connect the device.
20. **Start Measurement**
21. If this is a manual measurement, follow the prompts to manually set the external lightwave source to the proper test wavelength and select **Measure**.
22. Data finally appears on the PMD graph and in the data boxes.
23. Select **Clear/Restart** and Return to step 16 to test more DUT; otherwise, select **Done**.

The wavelength span (i.e., Start and Stop) and wavelength step size (i.e., Delta) of a PMD measurement should be adjusted to see general PMD trends. The step size should be narrow enough to see rapid PMD changes versus wavelength but wide enough to provide the best accuracy (the wider the step size the better the accuracy). The maximum arc (on the Poincare sphere) per step size should never exceed 180 degrees (maximum delay = $\pi/\Delta \omega$) since measurement errors will result. The following is a detailed procedure for optimizing the step size for a given device.

Discover the optimum wavelength step size

First, complete the external source preparation procedure and perform the general measurement procedure with the Delta wavelength step-size set for approximately the maximum stepsize possible without creating a 180 degree arc on the Poincare sphere during any one wavelength step. The maximum step-size ($\Delta \lambda$) can be estimated from the expected maximum PMD of the test device.

Second, repeat the measurement, reducing the step size each time by 25% until the PMD data graph changes. Increase the step size back to the previous setting and perform the final PMD measurement.

For PMD tests near 1550 nm:
 $(\Delta \lambda) \times (\Delta \tau \text{ maximum}) = 4.0 \text{ nmmps}$

For PMD tests near 1300 nm:
 $(\Delta \lambda) \times (\Delta \tau \text{ maximum}) = 2.8 \text{ nmmps}$

where $\Delta \lambda$ = the wavelength step-size
 $\Delta \tau \text{ maximum}$ = the estimated maximum PMD
 $\Delta \omega = 2 \pi C \Delta \lambda / \lambda^2$

Polarization-maintaining fiber launch

Introduction

A polarization-maintaining fiber is designed to deliver a linearly polarized lightwave signal. When linearly polarized light is correctly launched onto a PMF cable, the light's polarization remains linear even when the cable is moved.

Maximum performance from a PMF cable is only obtained when linearly polarized light is launched into only one axis of the fiber; for example, the Y-axis of Figure 21. The quality of this launch is described as a dB extinction ratio relative to P_x ($10 \log(P_y/P_x)$).

The real-time Poincare sphere display of the Agilent 8509 makes this alignment process intuitive and straightforward. It takes only seconds to achieve better than 40 dB extinction ratios depending on the characteristics of the PMF cable.

The Agilent 8509 PMF launch technique uses the fact that if the launch into the PMF cable is misaligned then optical power is being sent into the orthogonal fast and slow axes of the PMF cable. The relative velocity or phase relationships between these two paths can be changed by slightly pulling or heating the fiber. This changes the cables output polarization and traces an arc on the 8509 Poincare sphere (refer to Figure 4 for a review of how phase relationships affect polarization). The 8509 calculates the PMF cable launch extinction ratio by using a circle that the user fits to the arc. The location of the arc and circle on the Poincare sphere are not important, since only the length of this circle's radius, R, is used to calculate the extinction ratio of the launch as shown in Figure 21. As the alignment is adjusted, the axis of the PMF cable will approach the linearly polarized input signal. Most of the opti-

cal power will be launched into one axis of the fiber and the arc on the Poincare sphere will approach a center point. The ideal alignment is at the center point of the arc.

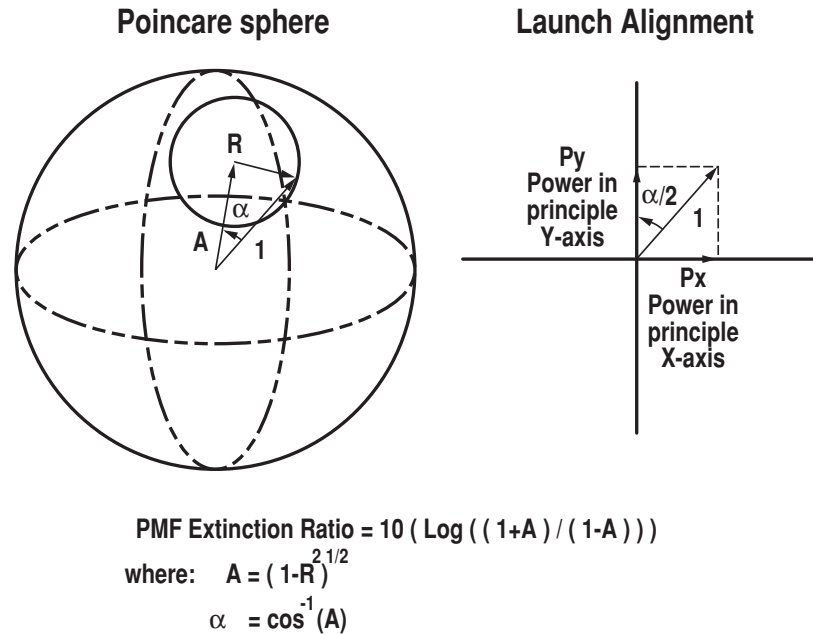

Figure 21. PMF cable launch extinction ratio is automatically calculated using the arc radius, R, created by stressing the PMF cable.

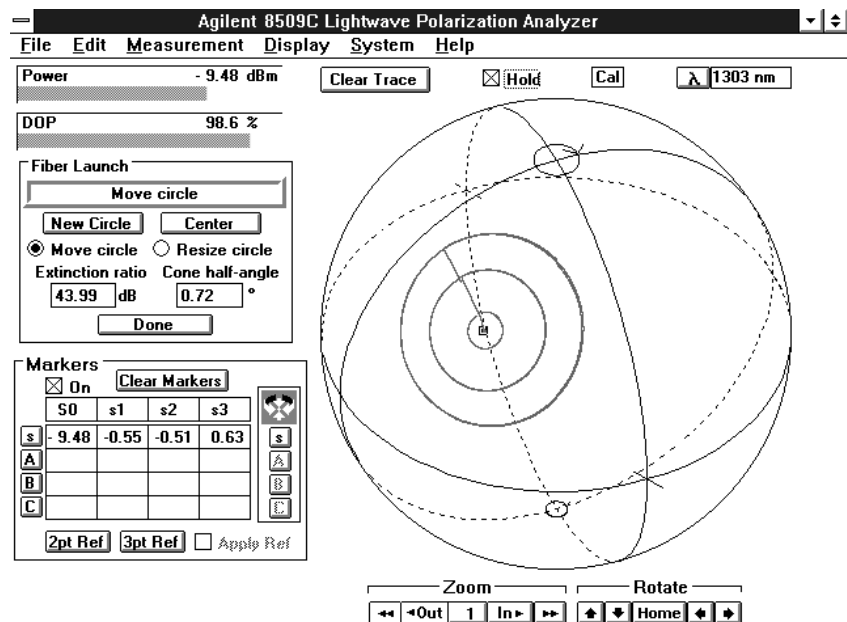

Figure 22. Typical Agilent 8509 PMF cable launch data display

Measurement setup

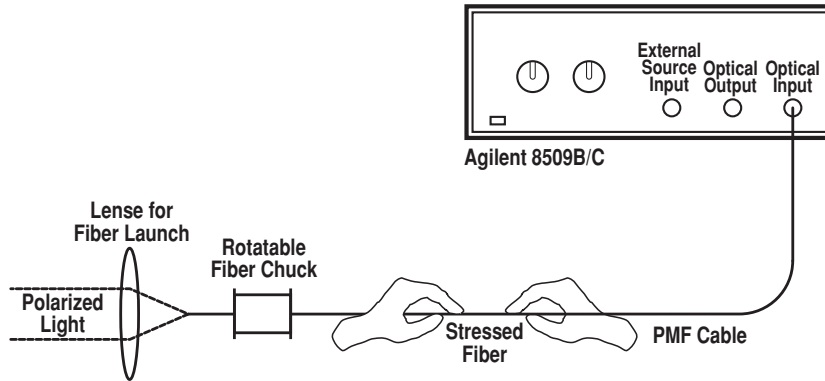

Figure 23. Setup for launching polarized light into a PMF cable.

Test procedure

Make the following selections on the display of the Agilent 8509 to align a PMF cable launch to the dB level shown in the extinction ratio data box.

Typical measurement procedure

1. **System**
2. **Optical Source**
3. Select the appropriate laser source and wavelength.
4. **Done**
5. **Measurement**
6. **PM Fiber Launch**
7. Slightly stress the PMF cable by pulling or heating it until an arc appears on the Agilent 8509 Poincare sphere.
8. Use the display arrow and the electronic mouse to place three points along this arc.
9. **Center**
10. Rotate the fiber chuck until that the active point on the Poincare sphere approaches the center of the circle.
11. Use the Poincare display **Zoom** and **Center** functions to optimize the view of the arc.
12. Slightly stress the PMF cable by pulling or heating it until an arc appears again.
13. **New Circle**, place three points on the arc using the electronic mouse.
14. Continue steps 9 through 13 until the value in the dB extinction ratio window is maximized.
15. Select **Done**; otherwise, connect the next PMF cable and return to step 7.

Appendix A

Agilent 8509 block diagrams and measurement capability summary

The Agilent 8509C contains a receiver and three linear polarizer plates. It measures optical signal polarization plus optical component polarization transfer functions.

Table 1.0: Summary of Agilent 8509B and 8509C measurement capabilities.

	State of Polarization	Degree of Polarization	Jones Matrix	Polarization-Dependent Loss	Polarization Mode Dispersion	Polarization Maintaining Fiber
Agilent 8509B	X	X	X*	X*		X
Agilent 8509C	X	X	X*	X		X
Agilent 8509C + tunable source	X	X	X*	X	X	X

*The Agilent 8509B and C perform this measurement with external polarizers. Only the Agilent 8509C can use its internal polarizers for this measurement.

Agilent 8509C

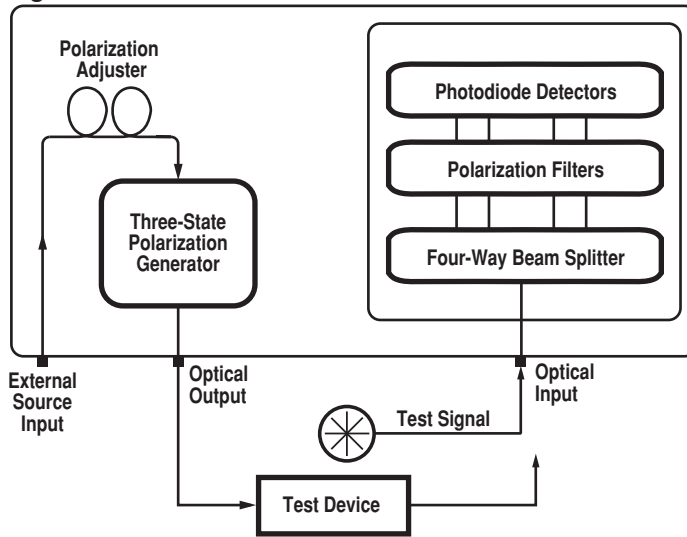

Figure 24. Agilent 8509B and 8509C Block Diagrams.

The receiver of the 8509B/C uses a stationary, four-diode detection scheme to quickly and accurately detect all possible polarization states. The beam is split into four separate beams. Each beam is passed through appropriate polarizing and retarding elements. Their respective power intensities are detected. The system computer calculates average optical power, horizontal, 45 degree and circular polarization components as defined by

classical Stokes parameters (refer to the “State of Polarization” section for further information on Stokes parameters). All measurement data is formulated and displayed based upon these Stokes parameters.

Polarization transfer function measurements (i.e., Jones matrix, polarization-dependent loss (PDL) and polarization-mode dispersion (PMD)) require the receiver just described, plus an optical source, an accurate,

three-state polarization generator, and additional application software for data calculations. All of these are built inside the 8509C system. The 8509C has two internal CW Fabry-Perot sources. An external source interface allows signals from other sources to be passed through the internal polarization generator and used with the 8509C receiver.

Appendix B

Table 2.0: Summary of relationships between the Jones vector, the Stokes vector, the Poincare sphere and the Polarization ellipse³

Jones Vector	Stokes Vector
$\begin{bmatrix} A_x e^{j\phi_x} \\ A_y e^{j\phi_y} \end{bmatrix}$	$\begin{bmatrix} S_0 \\ S_1 \\ S_2 \\ S_3 \end{bmatrix} = \begin{bmatrix} I \\ I_0 - I_{90} \\ I_{45} - I_{-45} \\ I_{rcp} - I_{lcp} \end{bmatrix} = \begin{bmatrix} A_x^2 + A_y^2 \\ A_x^2 - A_y^2 \\ 2A_x A_y \cos(\Delta) \\ 2A_x A_y \sin(\Delta) \end{bmatrix} = \begin{bmatrix} 1 \\ \cos(2\omega)\cos(2\alpha) \\ \cos(2\omega)\sin(2\alpha) \\ \sin(2\omega) \end{bmatrix}$ <p style="text-align: right;">(for unit intensity)</p>

Poincare Sphere Coordinates

$$X = \cos(2\omega)\cos(2\alpha) \quad Y = \cos(2\omega)\sin(2\alpha) \quad Z = \sin(2\omega)$$

Definitions

$$E = A_x e^{j\phi_x} \mathbf{i} + A_y e^{j\phi_y} \mathbf{j}; \quad A_x, A_y \geq 0$$

$$\Delta = \phi_y - \phi_x; \quad -180^\circ < \Delta \leq 180^\circ$$

$$\beta = \text{inv tan}(A_y/A_x); \quad 0^\circ \leq \beta \leq 90^\circ$$

$$\text{Azimuth of polarization ellipse} = \alpha; \quad -90^\circ < \alpha \leq 90^\circ$$

$$\text{Ellipticity of polarization ellipse} = \tan[\omega] = b/a:$$

$$-45^\circ \leq \omega \leq 45^\circ; \quad a \geq b \geq 0$$

a = length of semi-major axis

b = length of semi-minor axis

$\omega > 0$ implies right handed polarization

$\omega < 0$ implies left handed polarization

$$\alpha = 2^{-1} \text{inv tan} [\tan(2\beta)\cos(\Delta)] = [2^{-1} \text{inv tan} (S_2/S_1)]$$

$$\tan(\omega) = \tan(2^{-1} \text{inv sin} [\sin(2\beta)\sin(\Delta)]) = \tan [2^{-1} \text{inv sin} (S_3/S_0)]$$

$$\Delta = \text{inv tan}[\tan(2\omega) \sin(2\alpha)]$$

$$\beta = 2^{-1} \text{inv cos}[\cos(2\omega)\cos(2\alpha)]$$

Appendix C

Jones matrix calculation technique

The 8509C automatically calculates the Jones matrix of a component using three different, known, linear states of polarization (typically at 0, 60 and 120 degrees). These are created using either the internal polarizer plates of the 8509C or an external, rotatable, linear polarizer as shown in Figure 25. Each state of polarization individually stimulates the DUT while the output polarization is measured and recorded. It has been shown by R.C. Jones that this polarization information is sufficient for the 8509C to calculate a Jones matrix⁴. The simple case where the known polarized inputs are 0, 45 and 90 degrees is shown in Figure 25.

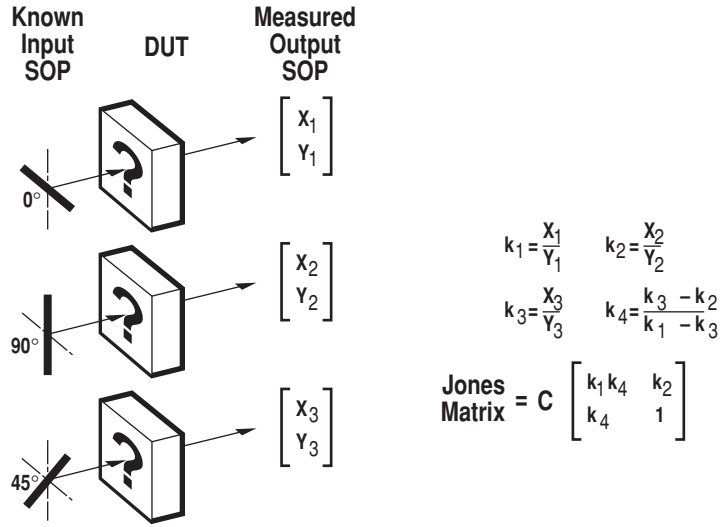

where X_n and Y_n are the Jones vector components and C is a constant.

Figure 25. The Jones matrix for an unknown component (?) is calculated by comparing the output Jones vectors to three known input Jones vectors.

Appendix D

Polarization-dependent loss calculation technique

The 8509 uses a Jones matrix analysis technique to calculate the PDL of optical components. It begins by measuring the combined relative Jones matrix, $cVAU$ (refer to the "Polarization Transfer Function" section for further information about Jones matrices). It is assumed that V and U are unitary Jones matrices which, in this case, means they represent lossless networks and will not affect the singular values (defined in Figure 26) of the Jones matrix for the test device A . The c term is an unknown complex constant introduced by the Jones matrix measurement technique. " c " has no effect in the final PDL calculation since it cancels out in the $s_1^2(B)/s_2^2(B)$ ratio of Figure 26. It can be shown that this square of the ratio of the singular values, $s_1^2(B)/s_2^2(B)$, equals the range of power change (T_{min}/T_{max}) that any transmitted signal might experience regardless of its original input state of polarization.

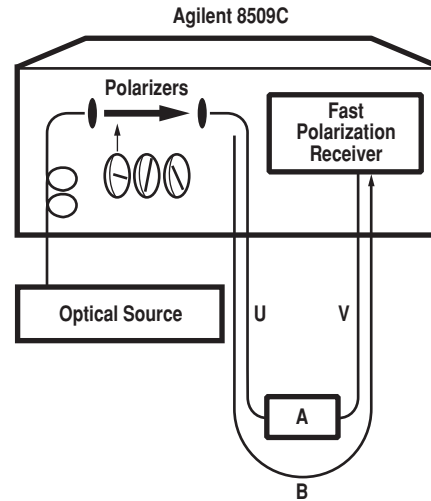

Definition of singular values:

$$s_i(\mathbf{A}) = \rho_i(\sqrt{\mathbf{A}^* \mathbf{t} \mathbf{A}})$$

Invariance of singular values under unitary transformations:

$$s_i(\mathbf{A}) = s_i(\mathbf{VAU})$$

Measurement Limited to the entire Network:

$$\mathbf{B} = c \mathbf{VAU}$$

$$\text{Measurable PDL: } \frac{T_{\min}}{T_{\max}} = \frac{s_1^2(\mathbf{A})}{s_2^2(\mathbf{A})} = \frac{s_1^2(\mathbf{B})}{s_2^2(\mathbf{B})}$$

where \mathbf{A} , \mathbf{B} , \mathbf{U} and \mathbf{V} represent the Jones matrices for the elements indicated and T is the optical power transmission coefficient.

Figure 26. Agilent 8509 PDL information is derived from the Jones matrix of test component \mathbf{A} ⁵.

Appendix E

Polarization mode dispersion calculation technique

The 8509C uses a Jones-matrix eigenanalysis technique to measure PMD as outlined in Figure 27. This measurement begins with the Jones matrices, J_0 and J_1 , being measured at preselected wavelengths, λ_0 and λ_1 (radian frequencies ω_0 and ω_1). The differential group delay, $\Delta \tau$, in this wavelength region is related to the eigen-values, ρ_0 and ρ_1 , of the matrix product $J_0 J_1^{-1}$. An eigenvalue is defined as a complex constant which satisfies the following relationship.

$$\rho \times \mathbf{V} = \mathbf{J} \times \mathbf{V}$$

where

ρ = eigenvalue

= complex constant

\mathbf{J} = Jones matrix being analyzed

\mathbf{V} = eigenvector input to \mathbf{J} for which no polarization change occurs during signal transmission

It can be shown that the argument (see Figure 27) of the ratio of the eigenvalues (expressed in polar coordinates) divided by the frequency step, $\omega_0 - \omega_1$, yields the differential group delay. A complete frequency span is traversed by repeating this calculation for successive pairs of Jones matrices at different wavelength (λ_1 to λ_n) steps.

The eigenvectors and eigenvalues associated with each Jones matrix are not displayed by the 8509. These values can, however, be calculated outside the 8509, using the Jones matrix values extracted from the 8509C.

λ	\mathbf{J}	product	eigen values	PMD
λ_0	\mathbf{J}_0	$\mathbf{J}_0 \mathbf{J}_1^{-1}$	$\rho_0' \rho_1$	$\text{PMD}_{0,1}$
λ_1	\mathbf{J}_1	$\mathbf{J}_1 \mathbf{J}_2^{-1}$	$\rho_1' \rho_2$	$\text{PMD}_{1,2}$
λ_n	\mathbf{J}_n	$\mathbf{J}_n \mathbf{J}_{n+1}^{-1}$	$\rho_n' \rho_{n+1}$	$\text{PMD}_{n,n+1}$

where: \mathbf{J}_n = Jones matrix at λ_n
 λ_n, ω_n = nth wavelength, frequency
 ρ_n = eigenvalue at λ_n

$$\text{PMD}_{n,n+1} = \left| \text{Arg} \left(\rho_n / \rho_{n+1} \right) / (\omega_{n+1} - \omega_n) \right|$$

Figure 27. The 8509C extracts polarization mode dispersion delay from pairs of Jones matrices using an eigenanalysis technique⁶.

Technical references

- 1,3. D.S. Kliger, J. W. Lewis and C. E. Randall, *Polarized Light in Optics and Spectroscopy*. New York: Academic Press, 1990, pp. 59-128.
2. C. Hentschel, *Fiber Optics Handbook*. Hewlett-Packard Company, Edition 2, Jan. 1988, pp. 95.
4. R.C. Jones, "A new calculus for the treatment of optical systems. VI. Experimental determination of the matrix," *Journal of the Optical Society of America*, vol. 37, pp. 110-112, 1947.
5. B. Heffner, "Deterministic, Analytically Complete Measurement of Polarization-Dependent Transmission Through Optical Devices", *IEEE Photonics Technology Letters*, vol. 4, pp. 451-454, 1992 .
6. B. Heffner, "Automated Measurement of Polarization Mode Dispersion Using Jones Matrix Eigenanalysis", *IEEE Photonics Technology Letters*, vol. 4, pp. 1066-1069, 1992.

Agilent Technologies' **Test and Measurement Support, Services, and Assistance**

Agilent Technologies aims to maximize the value you receive, while minimizing your risk and problems. We strive to ensure that you get the test and measurement capabilities you paid for and obtain the support you need. Our extensive support resources and services can help you choose the right Agilent products for your applications and apply them successfully. Every instrument and system we sell has a global warranty. Support is available for at least five years beyond the production life of the product. Two concepts underlie Agilent's overall support policy: "Our Promise" and "Your Advantage."

Our Promise

Our Promise means your Agilent test and measurement equipment will meet its advertised performance and functionality. When you are choosing new equipment, we will help you with product information, including realistic performance specifications and practical recommendations from experienced test engineers. When you use Agilent equipment, we can verify that it works properly, help with product operation, and provide basic measurement assistance for the use of specified capabilities, at no extra cost upon request. Many self-help tools are available.

Your Advantage

Your Advantage means that Agilent offers a wide range of additional expert test and measurement services, which you can purchase according to your unique technical and business needs. Solve problems efficiently and gain a competitive edge by contracting with us for calibration, extra-cost upgrades, out-of-warranty repairs, and on-site education and training, as well as design, system integration, project management, and other professional engineering services. Experienced Agilent engineers and technicians worldwide can help you maximize your productivity, optimize the return on investment of your Agilent instruments and systems, and obtain dependable measurement accuracy for the life of those products.

By internet, phone, or fax, get assistance with all your test & measurement needs.

Online assistance:
www.agilent.com/comms/lightwave



Agilent Email Updates

www.agilent.com/find/emailupdates
Get the latest information on the products and applications you select.

Phone or Fax

United States:
(tel) 1 800 452 4844

Canada:
(tel) 1 877 894 4414
(fax) (905) 282 6495

China:
(tel) 800-810-0189
(fax) 1-0800-650-0121

Europe:
(tel) (31 20) 547 2323
(fax) (31 20) 547 2390

Japan:
(tel) (81) 426 56 7832
(fax) (81) 426 56 7840

Korea:
(tel) (82-2) 2004-5004
(fax) (82-2) 2004-5115

Latin America:
(tel) (305) 269 7500
(fax) (305) 269 7599

Taiwan:
(tel) 080-004-7866
(fax) (886-2) 2545-6723

Other Asia Pacific Countries:
(tel) (65) 375-8100
(fax) (65) 836-0252
Email: tm_asia@agilent.com

Product specifications and descriptions in this document subject to change without notice.

